

AC3X-28.34

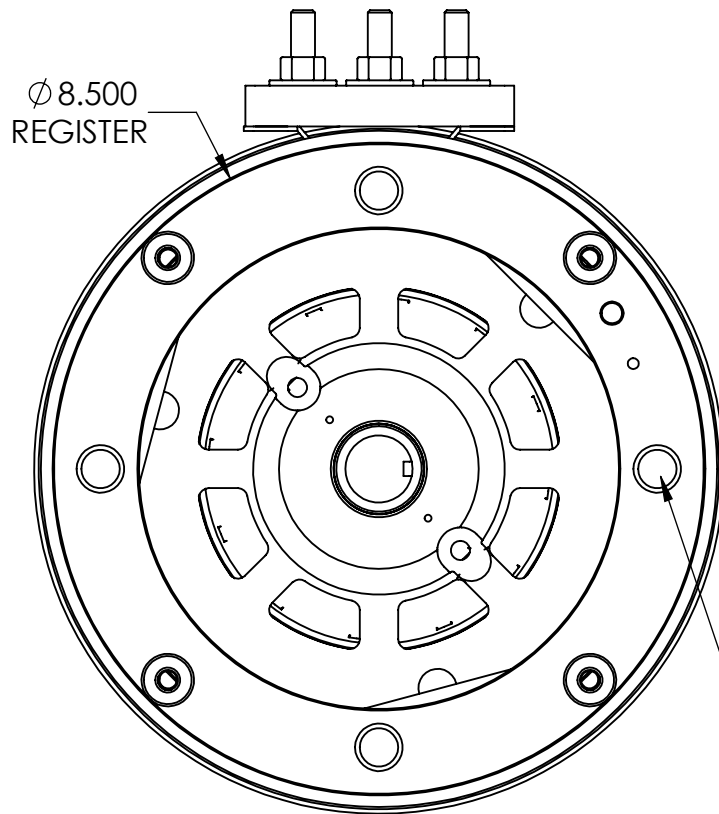

OPPOSITE
DRIVE END

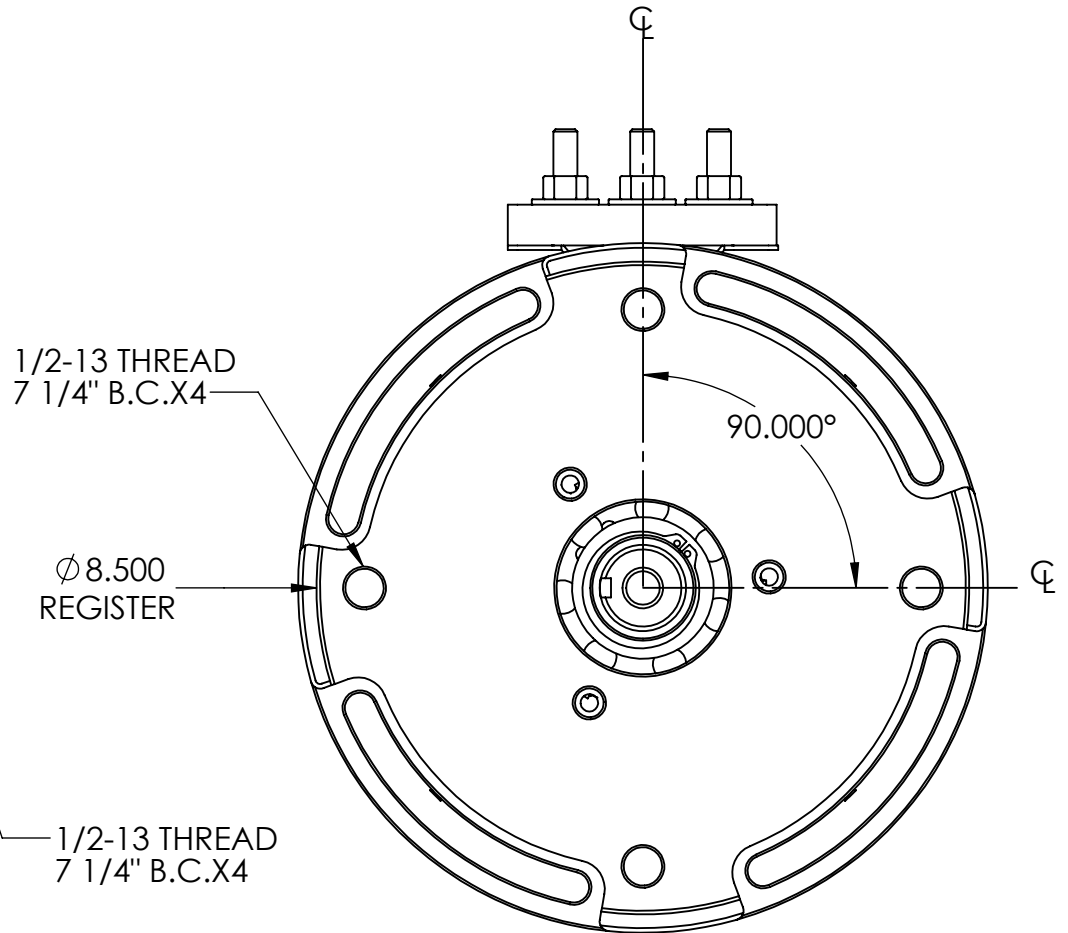

DRIVE END