

AC50/51-31.58 & AC50/51-31.59

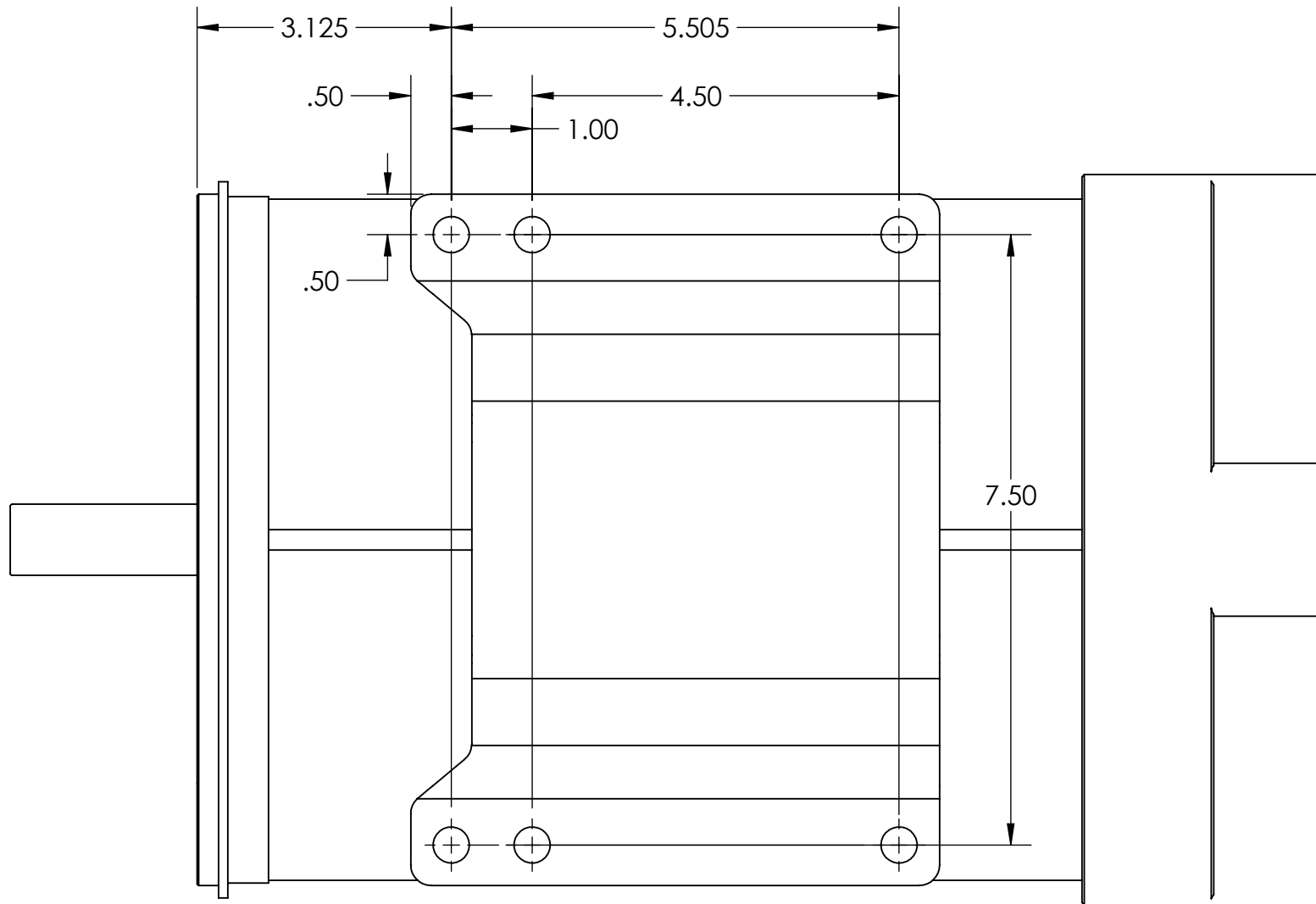

BOTTOM VIEW
(MOUNTING LAYOUT)